

EEMB CO., LTD

Lithium Thionyl Chloride Battery Specification

Energy Type

Model:	ER10250
Capacity:	400mAh

Prepared	Checked	Approved

Customer :

Customer Approval (Customer confirmation):		
Signature	Checked	Approved

Address: Room ABCD, 25/F, Block A, Fortune Plaza, NO.7060 Shennan Road Shenzhen, China

Postal code: 518040

Phone: 0086-755-83022275

Fax: 0086-755-83021966

<http://www.eemb.com>

Battery Structure

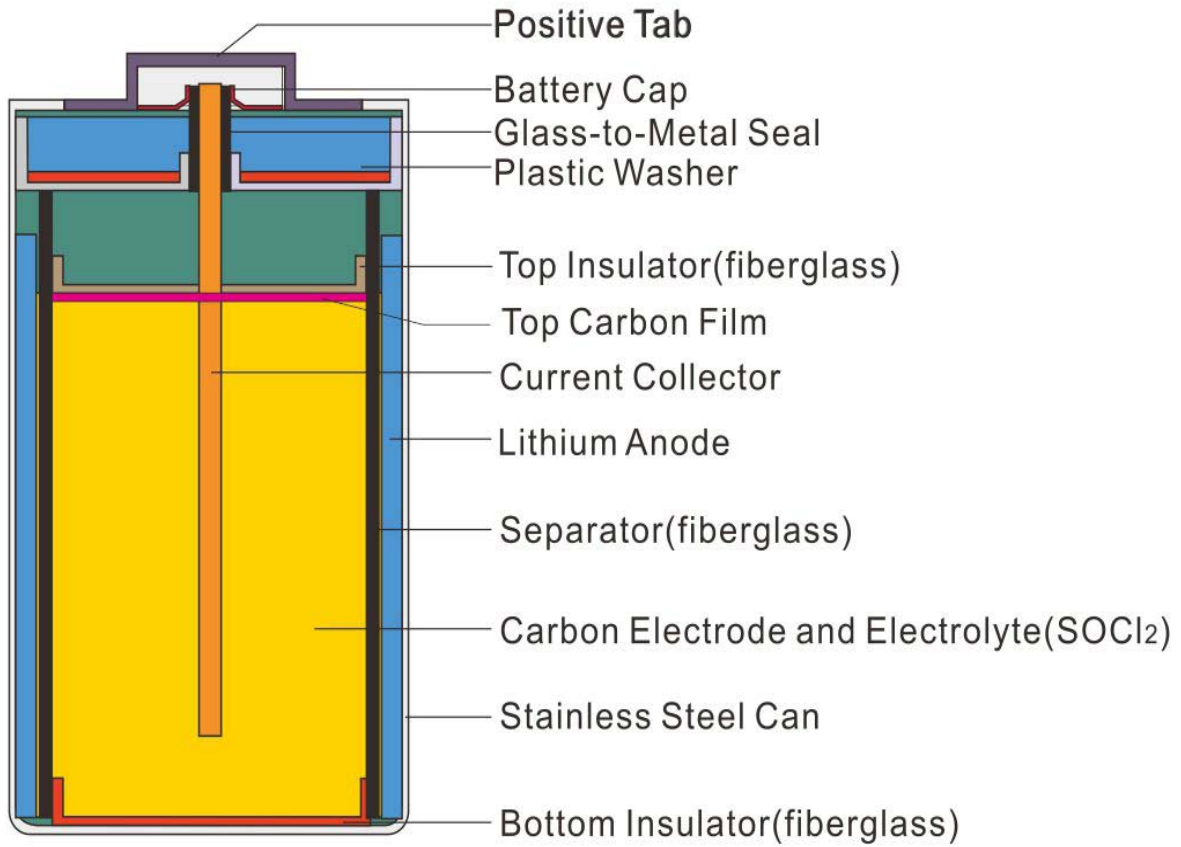

Catalog

Chapter	Content	Page
0	Catalog.....	3
1	Scope.....	4
2	Features and Applications	4
3	Battery Basic Characteristics.....	4
4	Battery Dimension.....	5
5	Appearance.....	5
6	Characteristics Curve.....	5~6
7	Memory Backup Circuit Design Suggestion.....	6
8	Matters Needing Attention.....	7

1. Scope

This product specification defines the requirements of the Lithium Thionyl Chloride battery supplied to the customer by EEMB Co., Ltd.

2. Features and Applications

Features:

- Excellent shelf life (10 years at room temperature).
- Low self-discharge (1% or less per year).
- Suited for long-term use with low current.
- Best suit for low current discharge
- Wide temperature range from -55°C to +85°C
- Bobbin-type or flat cells.

Applications:

- Water meters
- Gas meters
- Kilowatt per-hour meters
- Electronic Packing meters
- PC real-time clocks
- Medical Equipment
- CMOS memory backup

3. Battery Basic Characteristics

No.	Item	Characteristics
3.1	Model	ER10250
3.2	Nominal Capacity	400mAh
3.3	Nominal Voltage	3.6V
3.4	Standard Discharge Current	0.5mA
3.5	Max. Continuous Discharge Current	5mA
3.6	Max. Pulse Discharge Current	10mA
3.7	Discharge Cut-off Voltage	2.0V
3.8	Weight	Approx. 4g
3.9	Self-discharge Rate	≤1%
3.10	Operating Temperature	-55~85°C

Note:

1. For high rate discharge, the maximum operational temperature has to be lowered
2. Battery performance and battery capacity is function of current drain, temperature and cut off voltage.
3. Energy Type (bobbin structure) battery has very low self discharge on the shelf and during operation. It is best suited for low current discharges. It may require depassivation before medium currents can be delivered.
4. In order to calculate precise life time under various environments, as well as use battery in a safer way, we recommend you to consult EEMB.

4. Dimension (Unit: mm)

Item	Specification
D	Max. 10.4
H	Max. 25.0
d	Max. 5.3

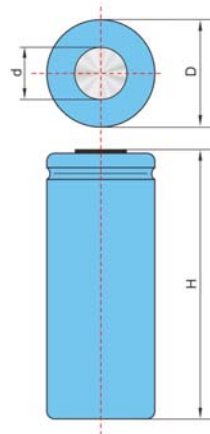

5. Appearance

It shall be free from any defects such as remarkable scratches, breaks, cracks, discoloration, leakage, or middle deformation.

6. Characteristics Curve

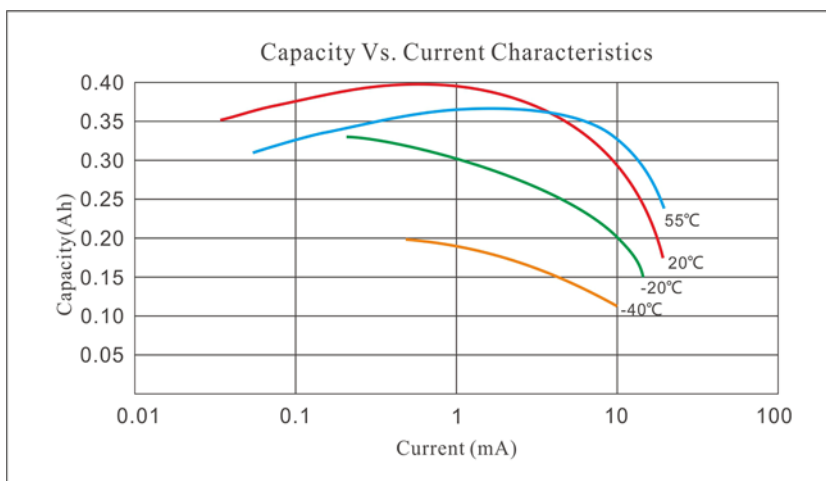
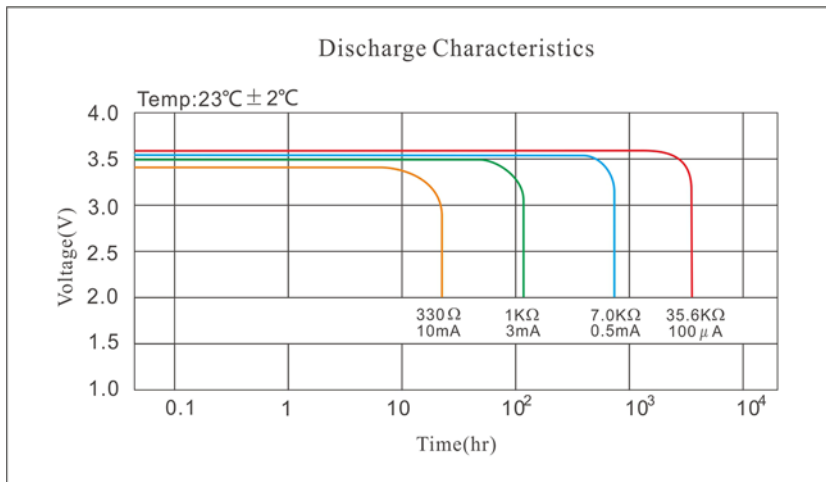

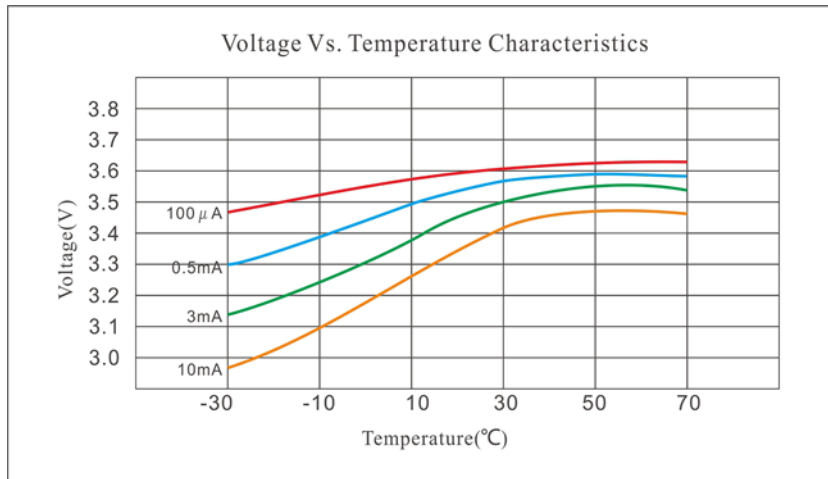

7. Memory Backup Circuit Design Suggestion

A primary lithium battery is not rechargeable, when used for memory backup in combination with another power source; current may flow into the battery from the other source. A protection diode and resistor into the circuit is needed to avoid battery charging or over discharging. Select a silicon diode or a diode with minimum leakage current, and design the circuit so that the amount of charging due to leakage current will not exceed 2% of the nominal battery capacity over the total period of use.

While used for memory backup, the following circuit shall be applied:

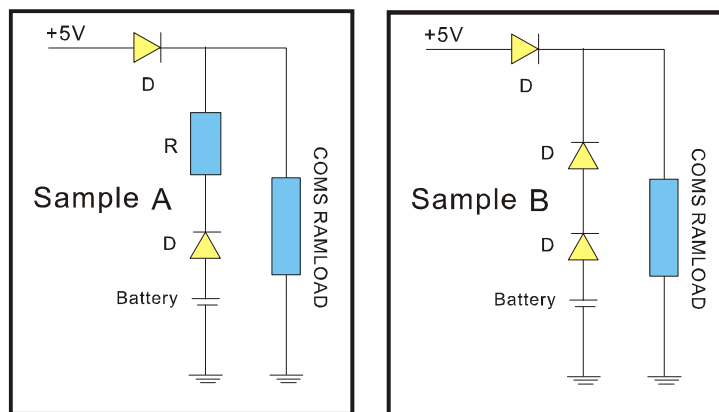

8. Matters Needing Attention

Strictly observes the following needing attention. EEMB will not be responsible for any accident occurred by handling outside of the precautions in this specification.

! Caution

- Use Nickel-plated iron or Nickel-plated stainless steel for the terminals that contact the battery.
- Make sure that terminal contact pressure is 50g minimum, for a stable contact.
- Keep the battery and contact terminal surfaces clean and free from moisture and foreign matter.
- Before inserting the battery, check the battery contact terminals to make sure they are normal, not bent or

damaged. (Bent terminals may not make good contact with the battery or may cause short circuit.)

- When the batteries are piled up in a disorderly way, their positive and negative terminals may short-circuit, consuming some batteries while charging others, causing explosion.
- Lithium batteries that are almost exhausted can output a voltage that is almost the same as that of a new battery: Please does not judge a battery only with a Voltmeter. Avoid using a mixture of old and new batteries; replace all batteries in a set with new one.
- Lithium batteries need a period of time to recover their normal voltage after even a slight short circuit. Therefore, if the battery is short-circuited, wait an adequate long time for batteries to recover before measuring their electrical characteristics.
- Use a high impedance (1M or higher) voltmeter to measure battery voltage.
- Battery characteristics vary with type and grade, even when batteries are the same size and shape. When replacing batteries with new ones, be sure to carefully check the symbols and numbers on them.

! Danger

- DO NOT recharge, short-circuit, disassemble, deform, heat or place the battery near a direct flame. This battery contains flammable materials such as lithium and organic solvent and performing any of the above actions could cause it to ignite explode or become damaged.
- DO NOT over-discharge the battery. In case the battery is over-discharged battery has potential of explosion. In case battery is over discharged, when connected with exterior power source or connected with other batteries in series, explosion may occur.
- Keep this battery out of the reach of children. If it is swallowed, contact a physician immediately.
- When storing a battery or throwing it away, be sure to cover it with tape. If the battery is contacted with other metal objects, it could cause fire or become damaged.

! Warning

- Thoroughly read the user's manual before use, inaccurate handling may cause leakage, heat, smoke, explosion, or fire, causing device trouble or injury.
- Insert the battery with the "+" and "-" ends correctly oriented.
- If the battery is used together with new batteries, do not use it with a different type battery.
- Do not solder the battery directly.
- Avoid storing the battery in direct sunlight, or in excessively hot and humid place.

EEMB reserves the final explanation. Please use battery strictly according to specification. EEMB will not be responsible for any inappropriate operation. EEMB keeps the right to change product specifications without previous notice. If any question, please consult with the manufacturer